

























# PARTYTÄLT PVC 6X8, 6X10, 6X12

Artikel		Beskrivning	Antal	Antal	Antal
		Storlek	<b>6x8m</b>	<b>6x10m</b>	<b>6x12m</b>
1		Galvaniserade rör Diameter: 38mm Längd: 1470mm	20	24	28
2		Galvaniserade rör Diameter: 38mm Längd: 1940mm	34	41	30
3		Galvaniserade rör Diameter: 38mm Längd: 1920mm	10	12	14
4		Galvaniserade rör Diameter: 25mm Längd: 1500mm	10	12	14
5		Galvaniserade rör Diameter: 25mm Längd: 510mm	5	6	7
6		3-vägskoppling	4	4	4
7		4-vägskoppling	6	8	10
8		3-vägskoppling	2	2	2
9		4-vägskoppling	3	4	5
10		4-vägskoppling	6	8	10
11		3-vägskoppling	4	4	4
12		Fot	4	4	4

13		Fot	6	8	10
14		Fot	4	4	4
15		Jordankare	4	4	4
16		Tältpinne, längre	10	12	14
17		Tältpinne, kortare	42	48	54
18		Elastisk stropp, kortare	26	26	26
19		Elastisk stropp, längre	132	152	172
20		Tältlina	4	4	4
21		Skruv	152	182	212
22		Mutter	20	24	28
23		Takduk	1	1	1
24		Gavel	2	2	2
25		Sidovägg	8	10	12

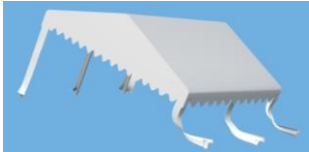

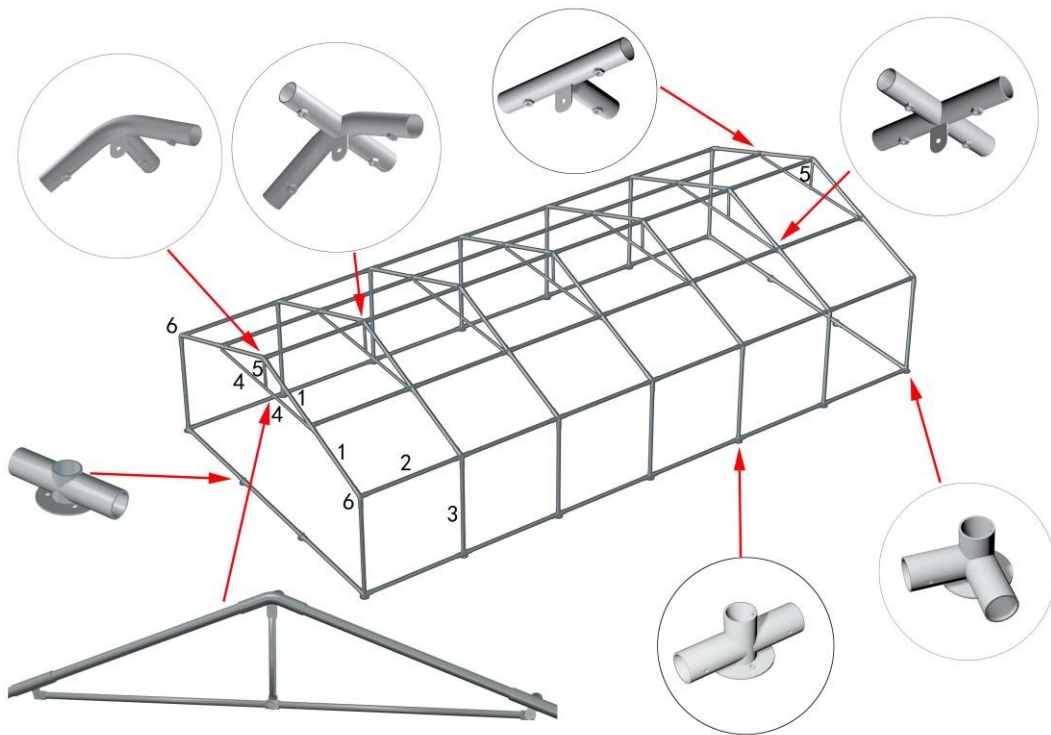
1. Placera ut alla leder (6,7,8,9,10,11) och rör (1, 2) på marken som bilden nedan visar. **Vid behov torka av rören.** Använd skruv (21) för att fixera dem.
2. Sätt ihop rören och lederna, starta med de tre mittersta raderna.

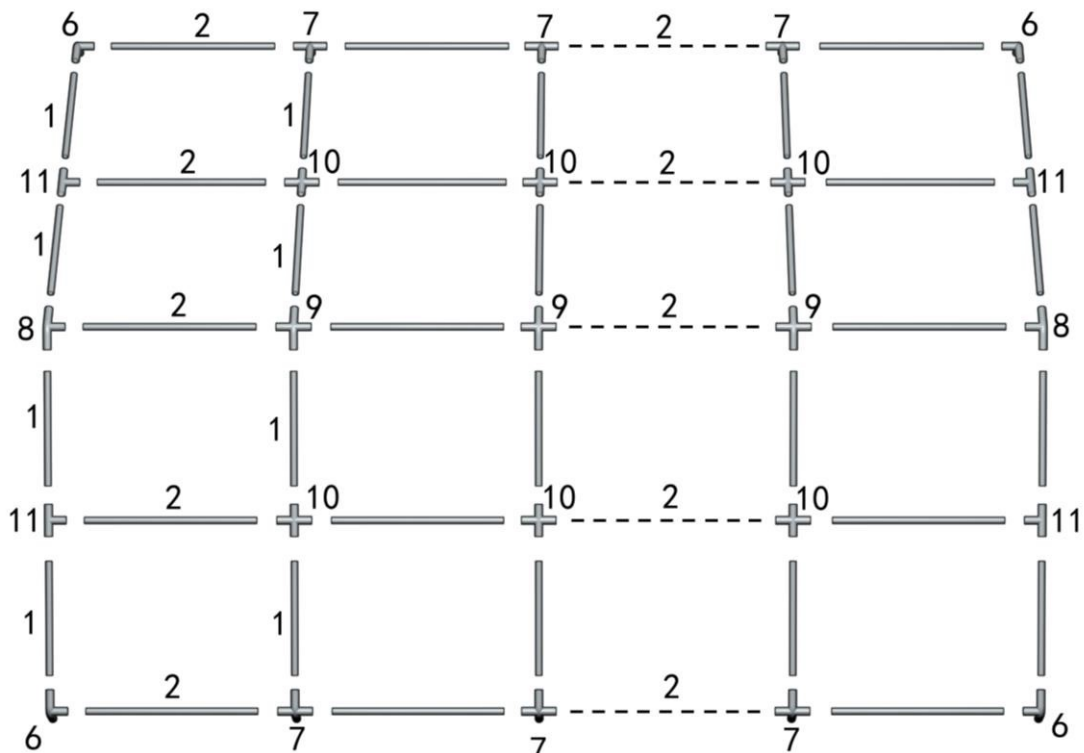



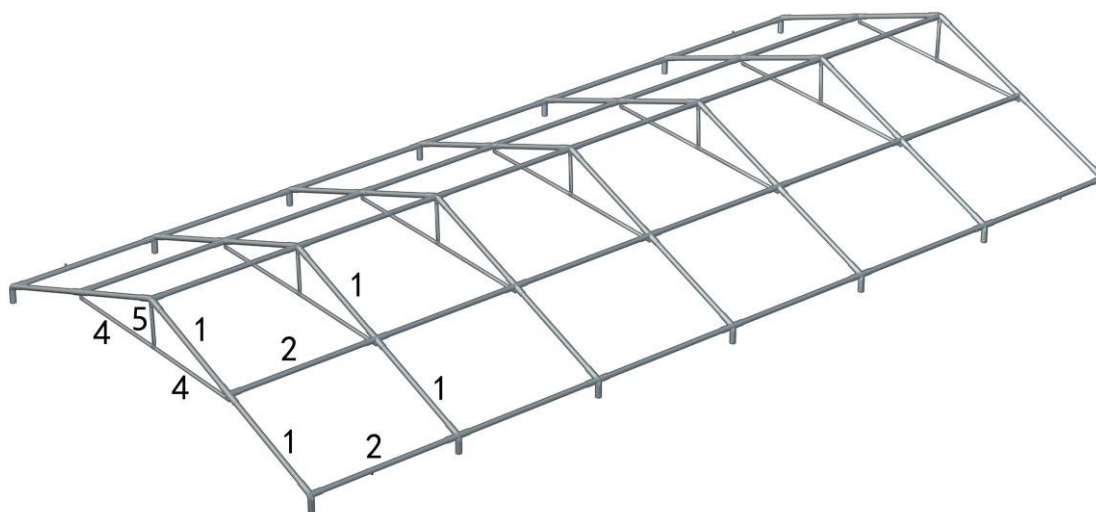

**3.** Montera rör 4 och 5, med skruv (21) och mutter (22).

**4.** Sätt sedan fast de två yttersta raderna.

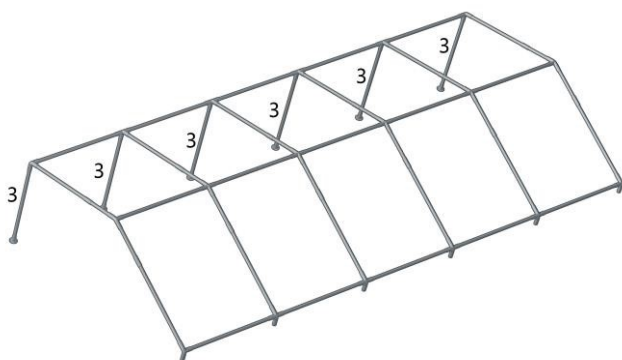
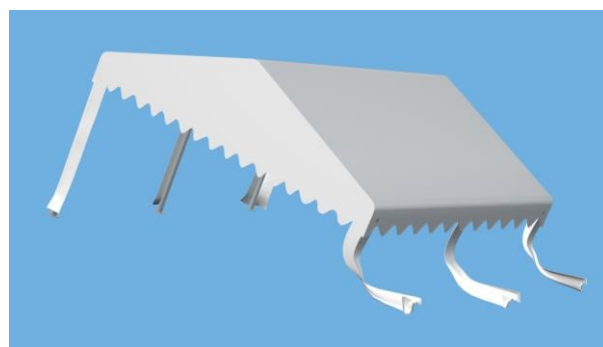
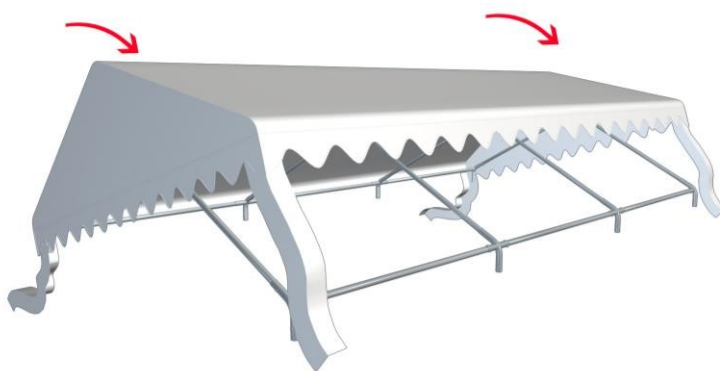

5. Bred takduken löst över det färdigmonterade taket
6. Montera ben (3) på ena långsidan.
7. Lyft den andra långsidan och montera resterande rör nr. 3. Fäst takduken med resårstroppar  
(19)

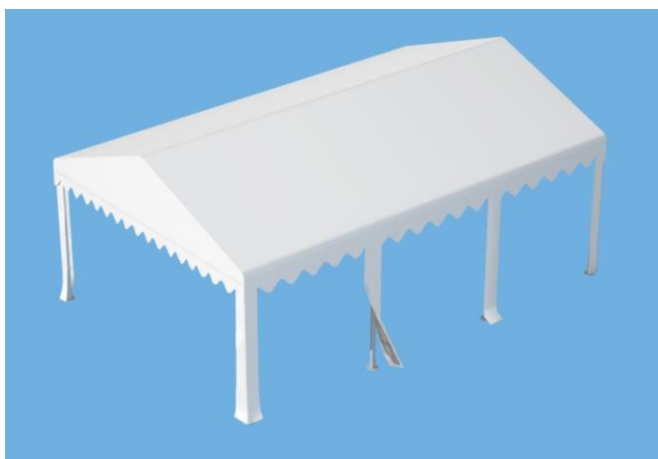

8. Montera bottenramen enligt skissen nedan. Fot (12,13,14) och rör (2).

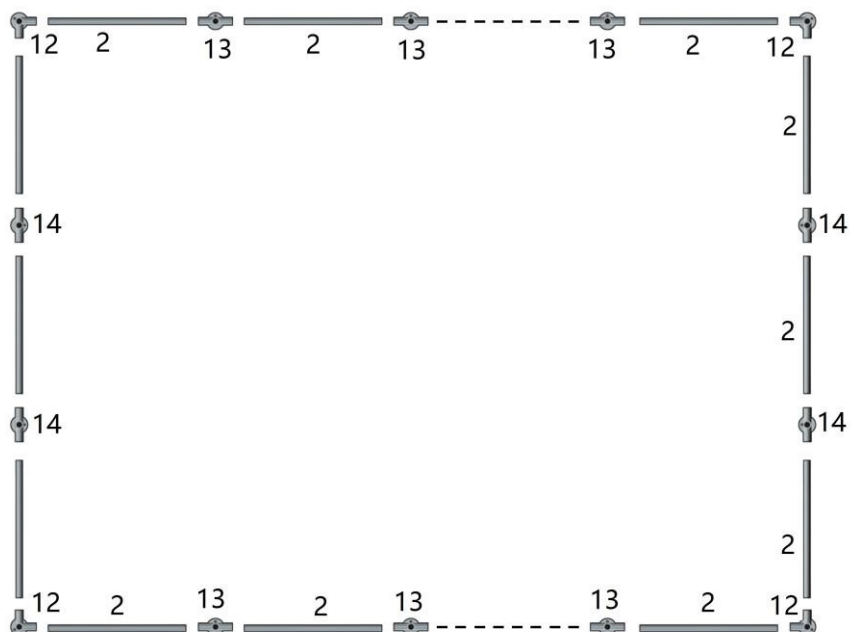

9. Sätt upp sidoväggar och gavlar. För att fästa dem används elastiska stroppar (19) till sidoväggarna. Elastiska stroppar (18) fästs mellan tak och gavlar.

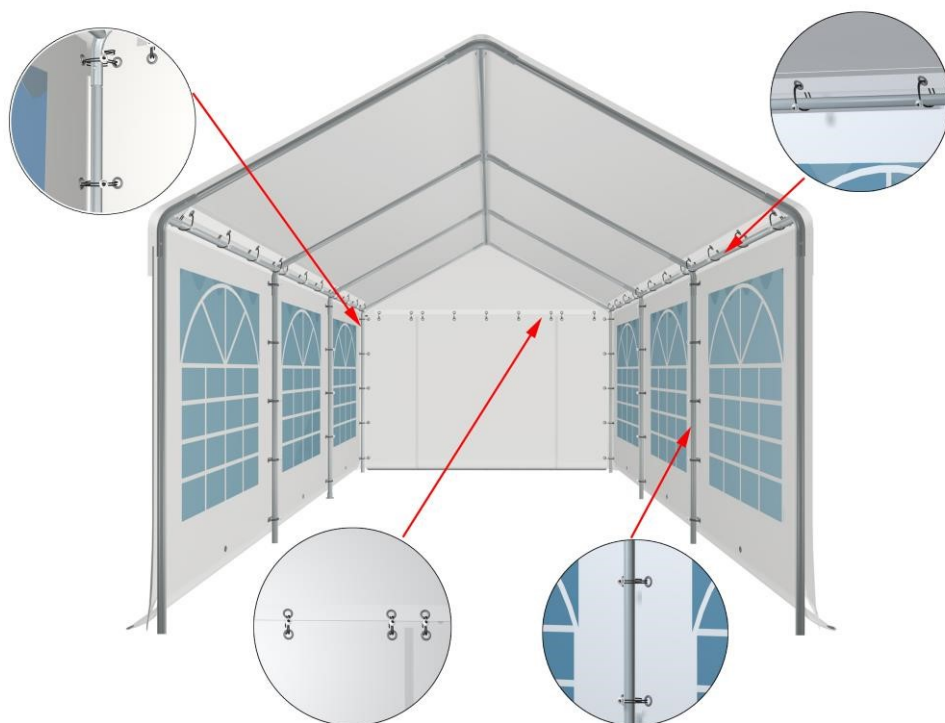
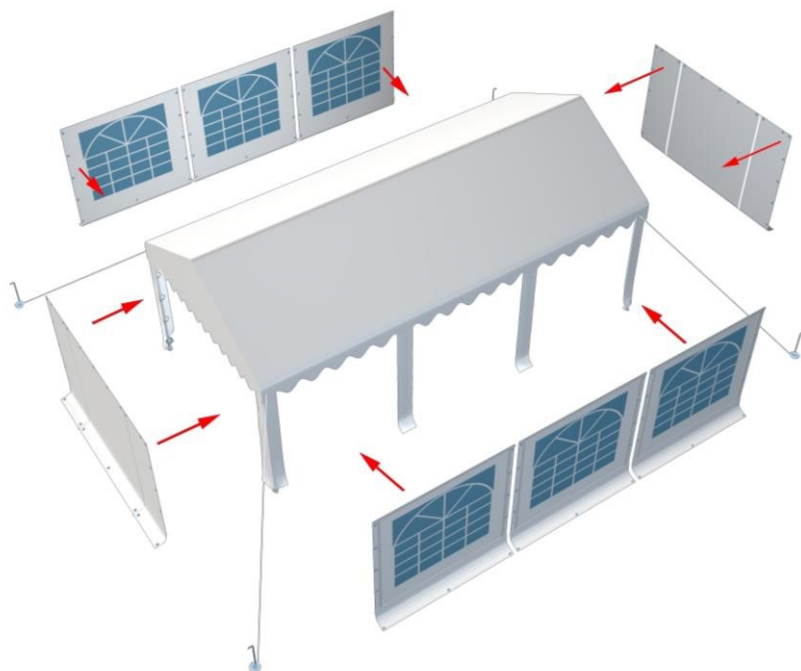

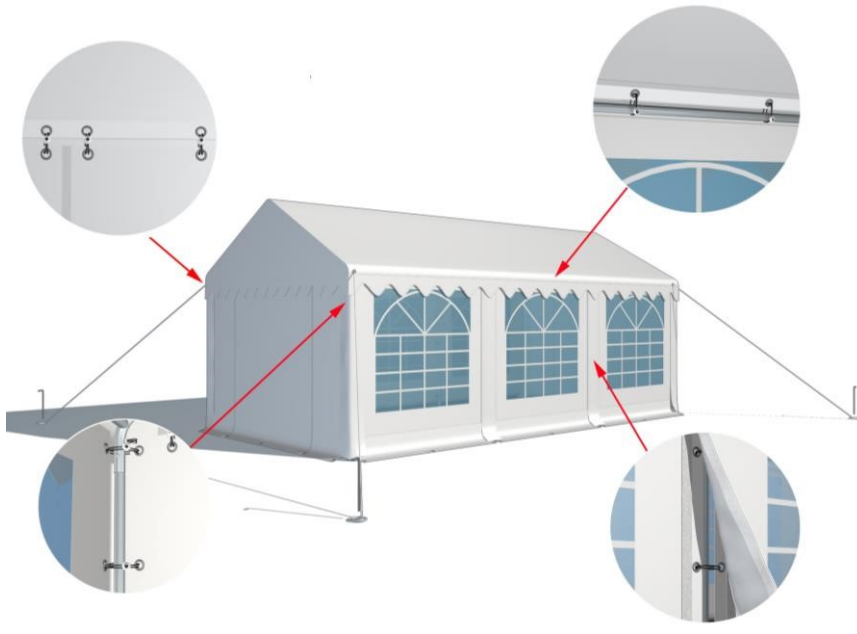

- 10.** Använd tältlinor och jordankare för att göra tältet mer stabilt. Fäst linorna i tältstommen, inte i tältduken.

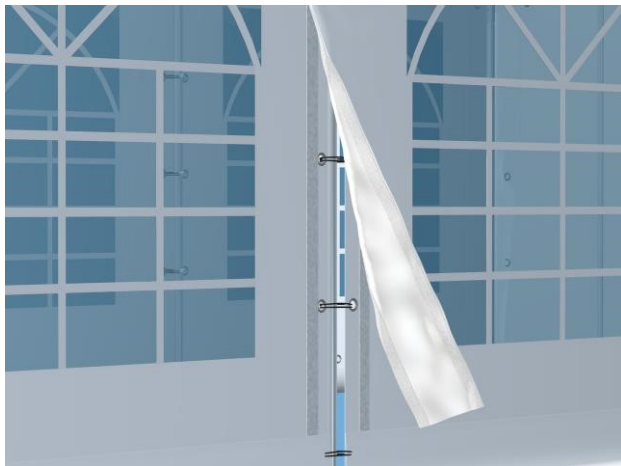

- 11.** Sätt de längre tältpinnarna (16) i stommens fötter och använd de kortare tältpinnarna (17) att fästa i tältdukens öljetter.



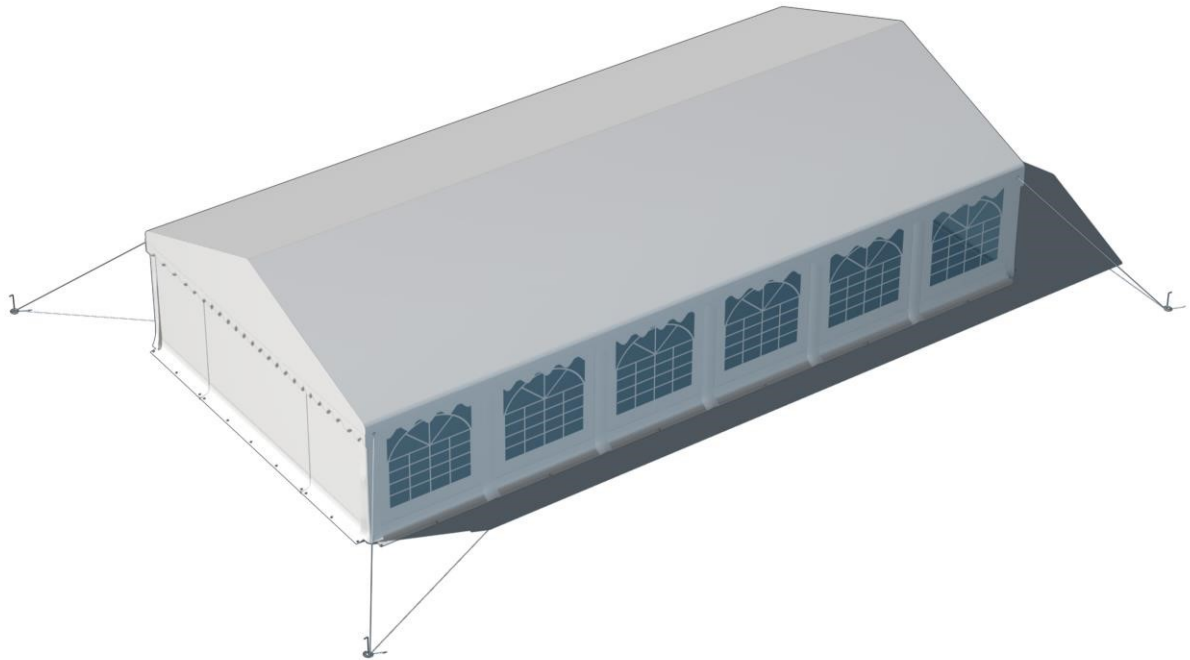







- 12.** Fäst takets fasta PVC-remsor med kardborrbanden på utsidan av tältet.

















## **Viktigt**

- Var försiktig med delarna vid uppsättning och nedmontering, så att de inte skadas. Om behov finns, använd spännband och jordspjut för extra förankring.
- Tältet är inte konstruerat för att stå uppsatt i längre perioder. Om det blir hårt väder skall det monteras ner.
- Hitta en lämplig plats för tältet. Undvik sprinklersystem och jordkablar.
- Även om denna produkt är brandhärdig måste man vara försiktig. Håll eld och andra öppna lågor borta från tältet.
- När tältet inte används skall det förvaras fuktfritt.
- Bilderna i denna manual är endast för illustration och kan skilja sig från den köpta modellen.

# PARTYTELT PVC 6X8, 6X10, 6X12

Artikel		Beskrivelse	Antal	Antal	Antal
		Størrelse	6x8m	6x10m	6x12m
1		Galvaniseret rør Diameter: 38mm Længde: 1470mm	20	24	28
2		Galvaniseret rør Diameter: 38mm Længde: 1940mm	34	41	48
3		Galvaniseret rør Diameter: 38mm Længde: 1920mm	10	12	14
4		Galvaniseret rør Diameter: 25mm Længde: 1500mm	10	12	14
5		Galvaniseret rør Diameter: 25mm Længde: 510mm	5	6	7
6		3-vejs samling	4	4	4
7		4-vejs samling	6	8	10
8		3-vejs samling	2	2	2
9		4-vejs samling	3	4	5
10		4-vejs samling	6	8	10

11		3-vejs samling	4	4	4
12		Fod	4	4	4
13		Fod	6	8	10

14		Fod	4	4	4
15		Jordanker	4	4	4
16		Pløk, lang	10	12	14
17		Pløk, kort	42	48	54
18		Elastiskstrop, kort	26	26	26
19		Elastiskstrop, lang	132	152	172
20		Teltline	4	4	4
21		Skrue	152	182	212
22		Møtrik	20	24	28
23		Tagdug	1	1	1
24		Gavl	2	2	2
25		Sidevæg	8	10	12



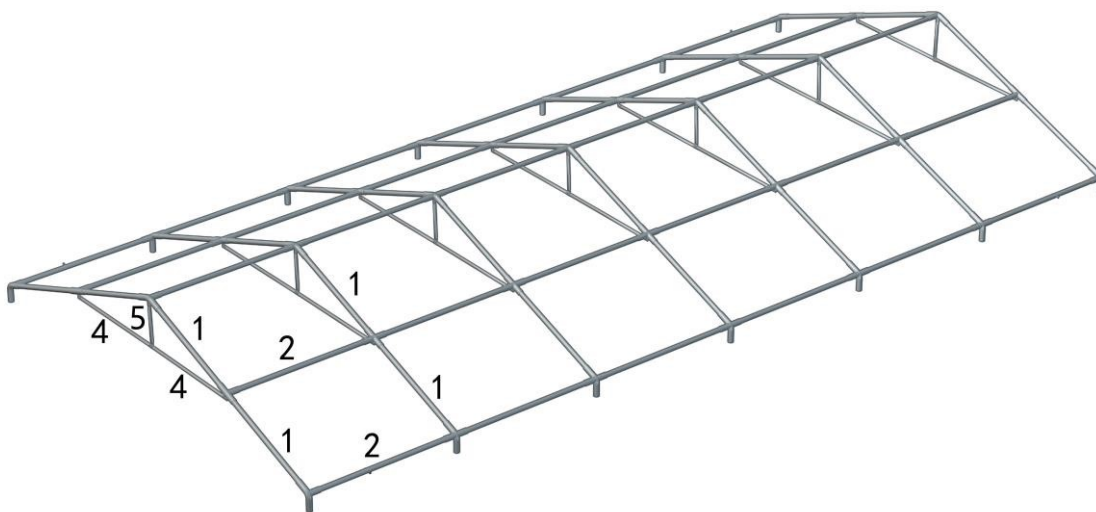
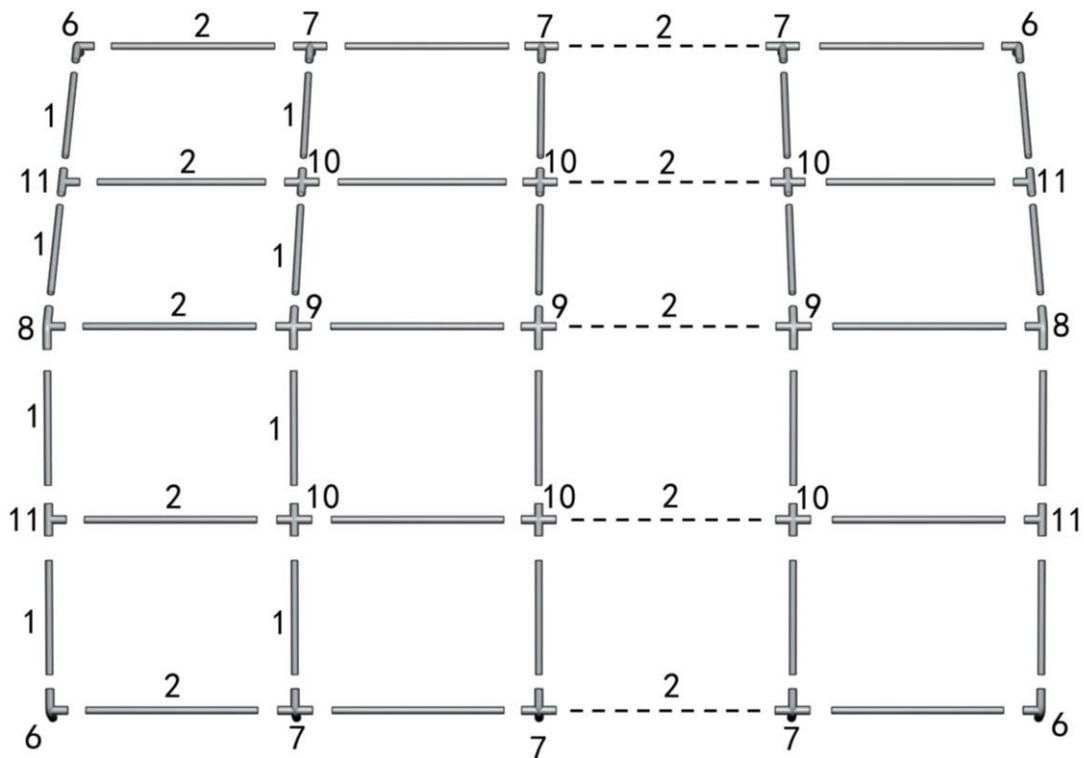

**10.** Monter rør 4 og 5, med skrue (21) og møtrik (22).

**11.** Monter herefter de to yderste rækker med åse.

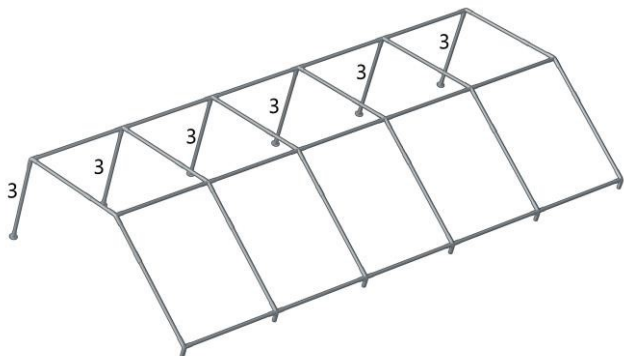
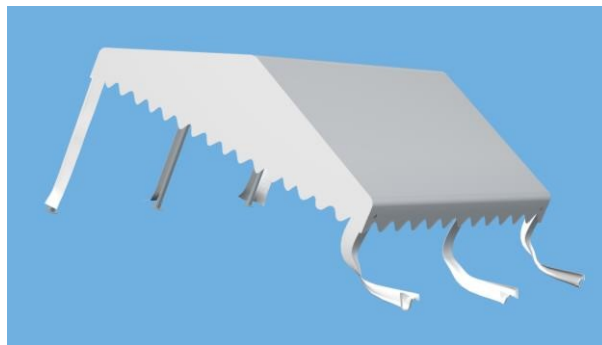
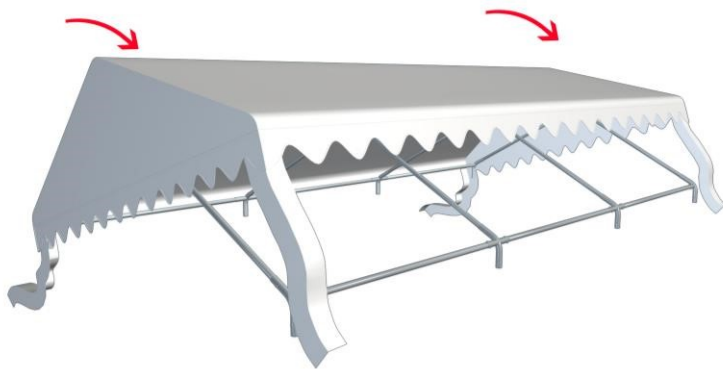

**12.** Læg tagdugen på

**13.** Monter ben (3) på den ene langside.

**14.** Løft den anden langside op og monter resterende rør nr. 3. Spænd tagdugen fast med elastikstropperne (19).

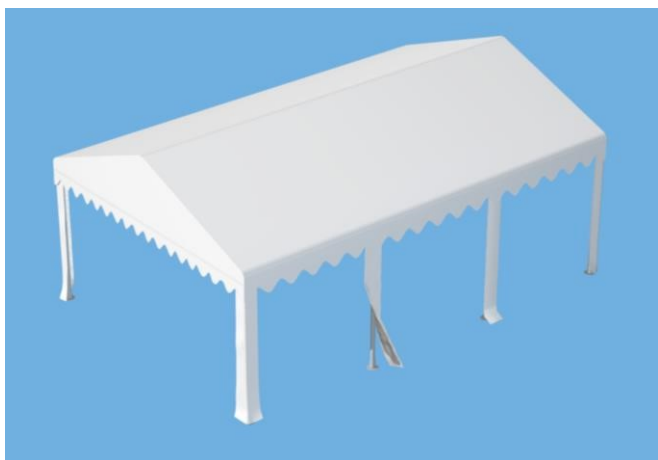

**15.** Monter bundrammen som vist på illustrationen nedenfor. Fod (12,13,14) og rør (2).

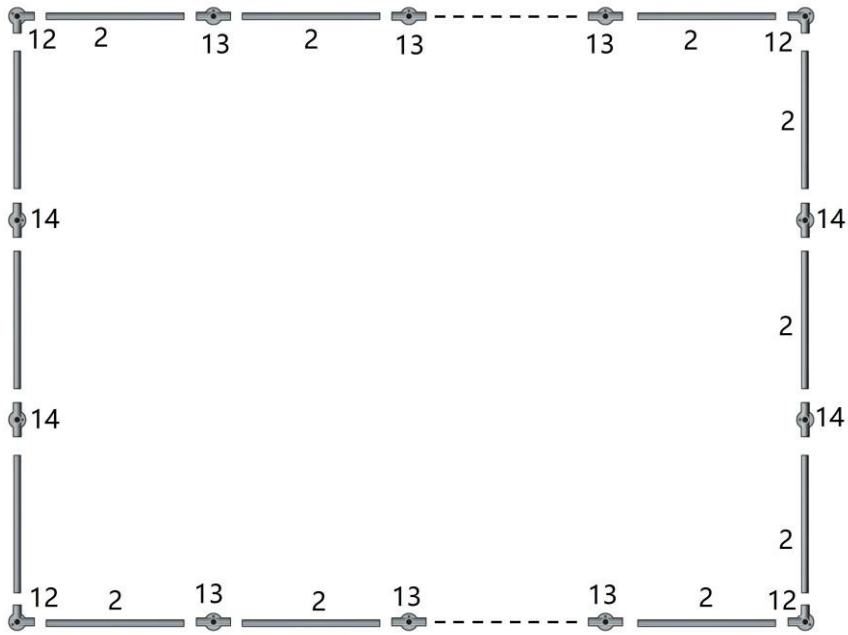

- 9.** Sæt alle sidevægge og gavle på. Anvend elastikstropperne til dette (19). Anvend de korte elastikstropper (18) i mellem tag og gavle.

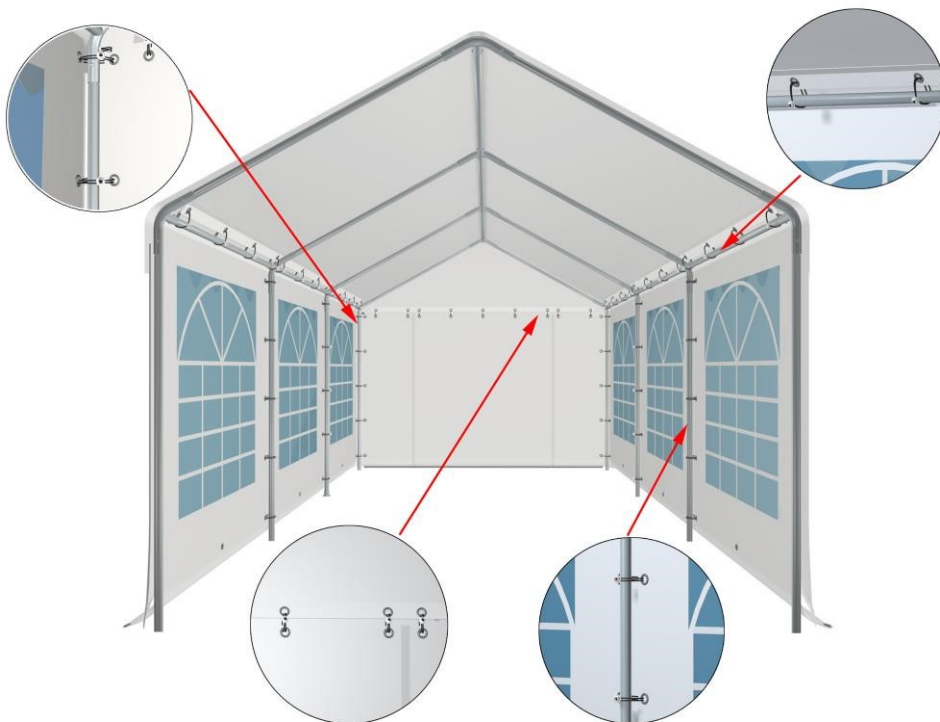
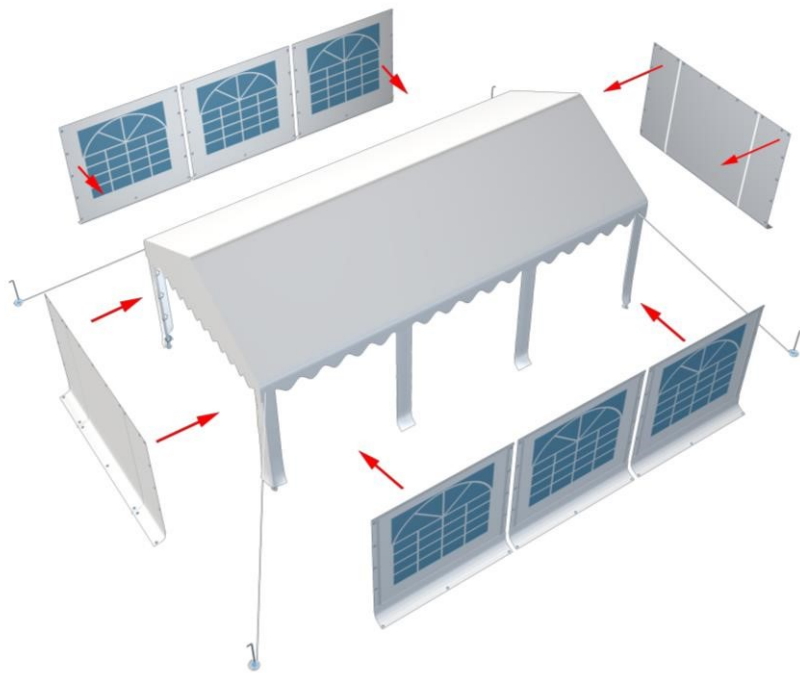

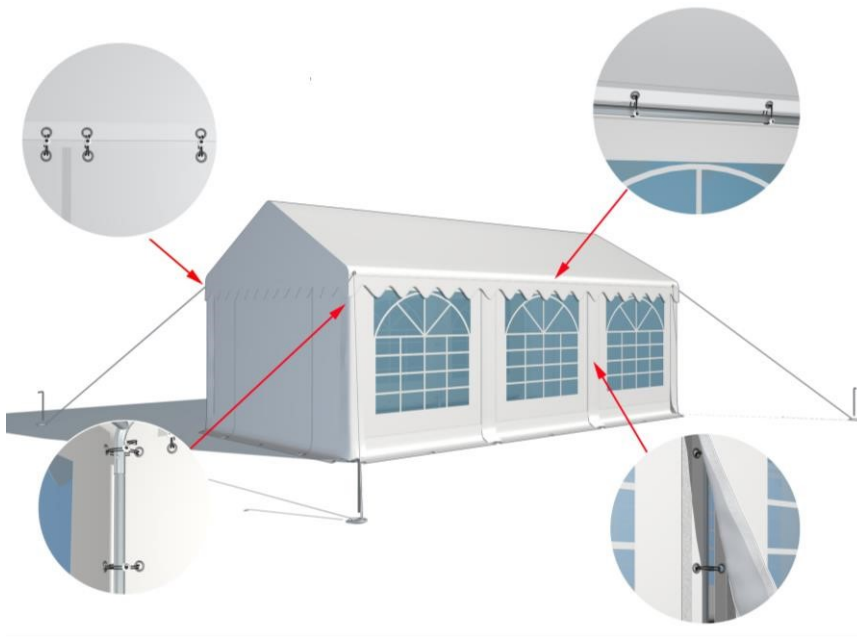

**10.** Monter tellliner og jordankere for at gøre teltet mere stabilt. Monter linerne i stellet. Ikke i teltdugen.

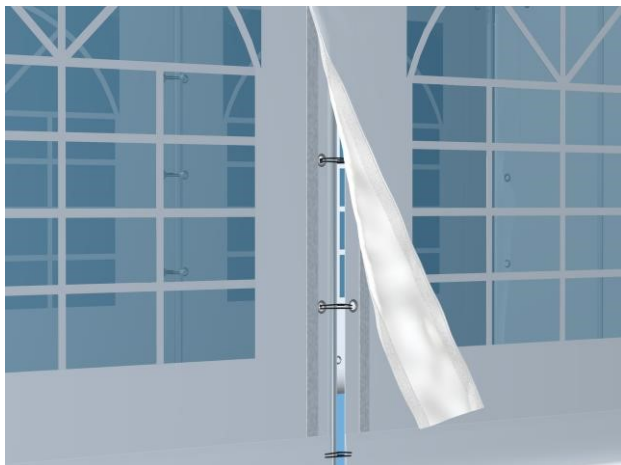

**11.** Monter de lange pløkke (16) i stallets fødder og anvend de korte pløkke i teltdugens øjer.

**12.** Sæt PVC-strimlerne der er monteret på tagdugen fast til sidevæggene og gavlene.

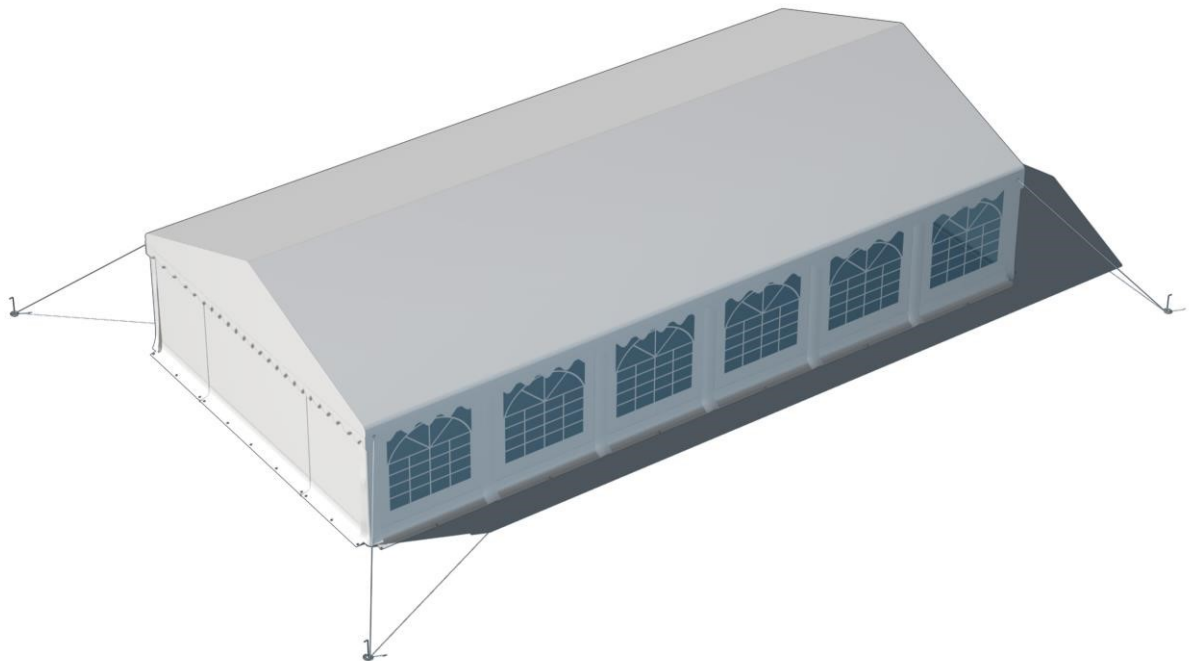

## **Vigtigt**

1. Vær forsigtig med delene under opsætning og nedtagning. Ellers kan de blive beskadiget.
2. Teltet er ikke konstrueret til at stå opsat i længere perioder. Hvis det bliver hårdt vejr skal det nedmonteres.
3. Find en egnet plads til teltet. Undgå sprinkleranlæg og kabler i jorden.
4. Selvom dette produkt er flamme hæmmende skal man være forsigtig. Hold åben ild og andre varme kilder væk fra teltet.
5. Når teltet ikke anvendes skal det opbevares tørt.
6. Billederne i manualen er kun til illustration og kan fravige den købte model.