

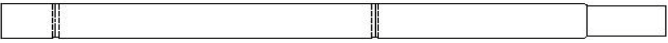









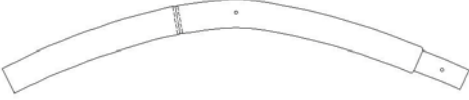
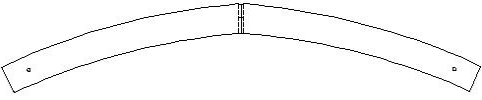
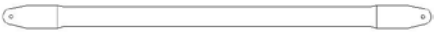



3.65X6M GARAGE

Parts no.		Beskrivelse	Antal
A		Ben	4
B		Ben	8
C		Gavl hjørne bue	4
D		Midter bue	6
E		Tag forstærkning	6
F		Diagonal forstærkn.	4
G		Midt hjørne bue	8
H		Ås	20
I1		Dør montagestang	2
I2		Dør montagestang	2
Z		Ås	5
J		Diagonal forstærkn.	4
K	Dug fastgørelse	10	
L		Elastik	44
M		Beslag	4
N		Bolt 2,5"	16
O		Bolt 3"	34
P		Dug Strammer	20

I Opbygning af midter buer:

- Tag en midter bue (D) og monter midter hjørne buerne (G).
- Monter tag forstærkningen (E) med bolte og vinge skruer.
- Gentag dette med alle midter buerne.



II Opbygning af gavl buer:

- Tag en midter bue (D) og monter gavl hjørne buerne (C).
- Monter tag forstærkningen (E).
- Monter dør montagestængerne med bolte (I1)(I2).

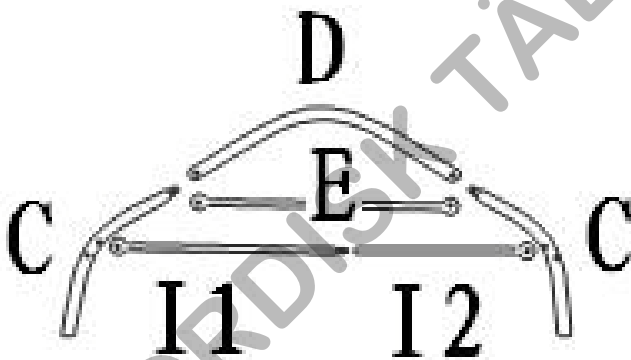

III Rejs garagen:

- Forbind alle buer med åsene (H)(Z).
- Monter benene (A)(B).
- Monter diagonal forstærkningerne. (J)(F).
- Anvend beslag og jordspyd for at fiksere teltet til underlaget.

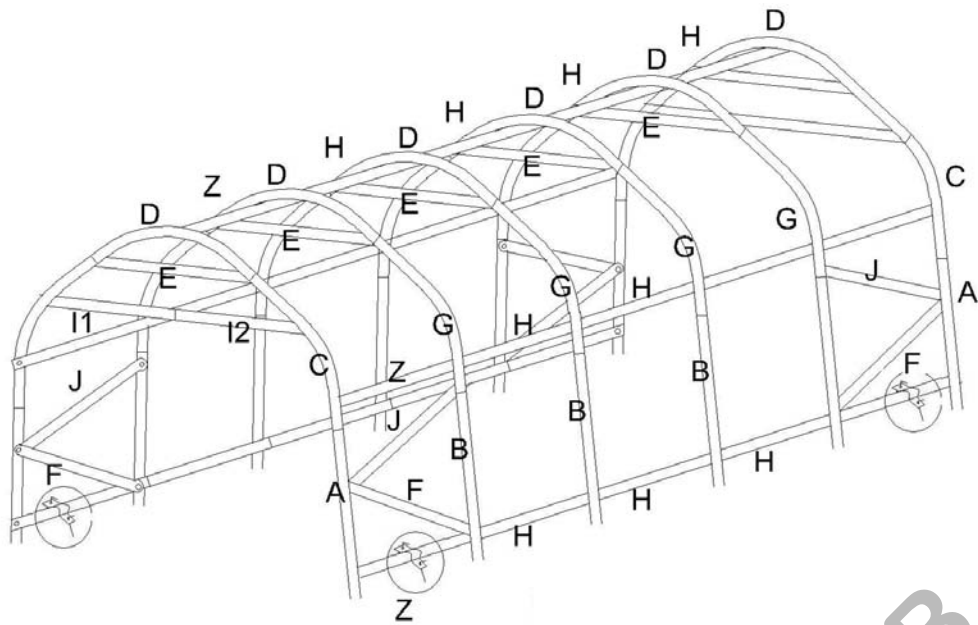

IV Monter dugen:



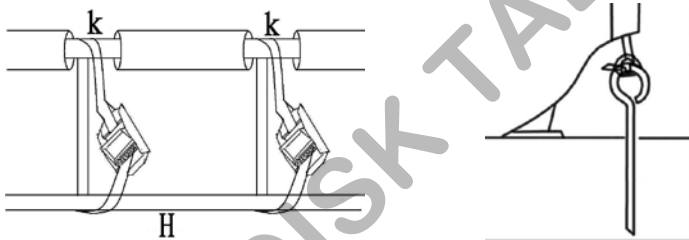



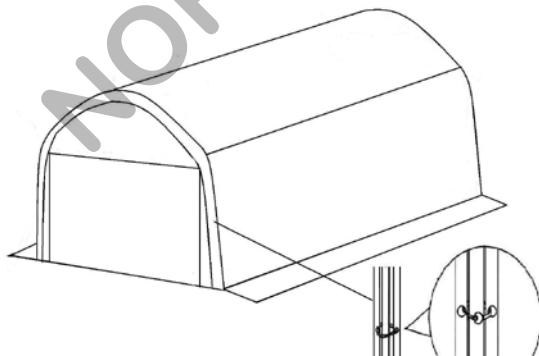





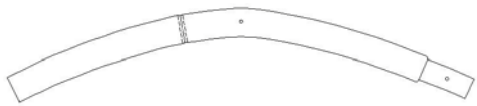
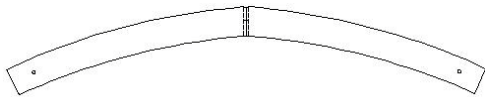
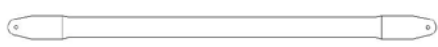

- Bred tag dugen ud over stellet.
- Monter dugen med dug strammerne (P) og (K).
- Stram dugen op med rebet der går igennem enderne af telt dugen.

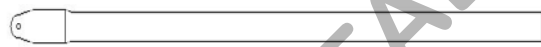

V Monter endevæggene med elastikker.

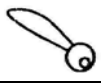

3.65X6M GARAGE TÄLT

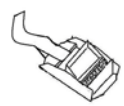
Parts no.		Beskrivning	Antal
A		Ben	4
B		Ben	8
C		Gavel hörnbåge	4
D		Mitt hörnbåge	6
E		Takförstärkning	6
F		Diagonal förstärkning	4
G		Mitt hörnbåge	8
H		Ås	20
I1		Dörrmonteringstång	2
I2		Dörrmonteringstång	2
Z		Ås	5
J		Diagonal förstärkning	4
K		Fästning av duk	10
L		Resårstroppar	44
M		Beslag	4
N		Bult 2.5"	16
O		Bult 3"	34
P		Dukspännare	20

I Montering av mittbågarna :

- Tag en mittbåge (D) och montera på hörnbågen (G).
- Montera takförstärkningen (E) med bultar och vingskruvar.
- Montera alla mittbågarna.



II Montering av gavel båge.

- Tag en mittbåge (D) och montera gavel hörnbåge.
- Montera takförstärkning (E).
- Montera dörrmonteringstängerna med bultar.

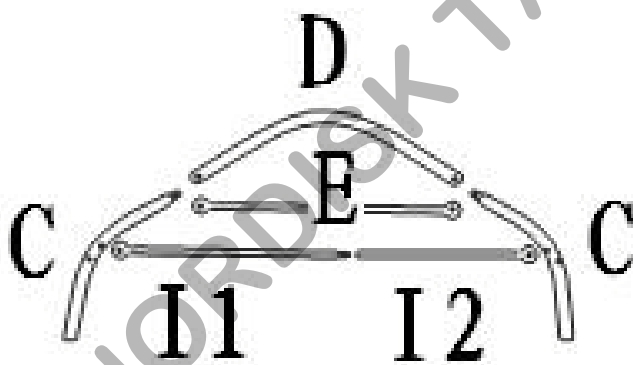

III Res garaget.

- Montera samman bågarna med åsarna (H)(Z).
- Montera benen (A)(B).
- Montera de diagonala förstärkningarna (J)(F).
- Använd beslag och jordspett för att fixera tältet till underlaget.

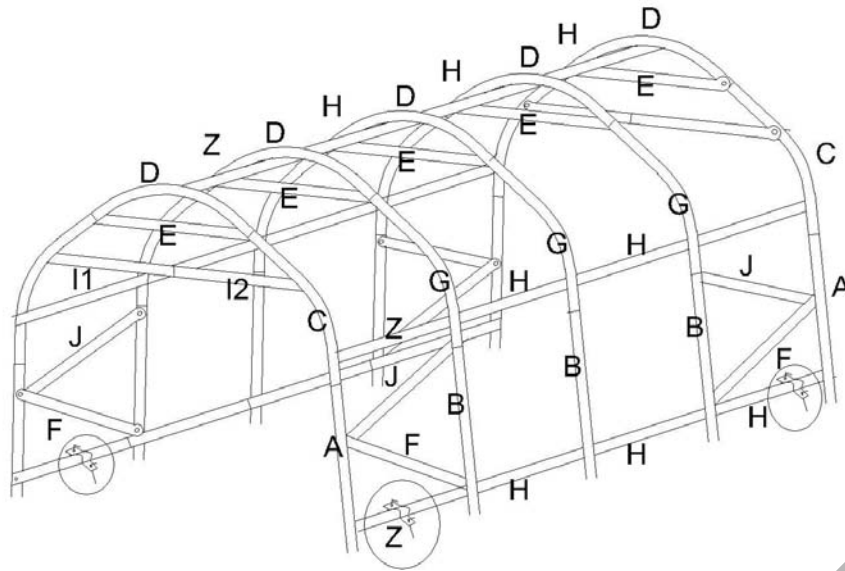

IV Montera duk.

- Bred takduken över stommen.
- Montera duken med dukspännarna (P) och (K).

Spänn upp duken med repet som går genom ändarna av tält duken

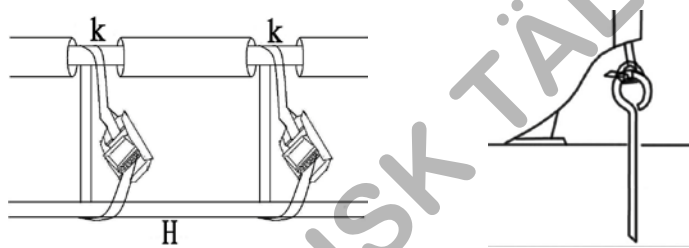

V Montera gavlarna med resårstroppar.

